



**Automatic Electric Gun (A.E.G.)
Adjustable Hop Up
Metal Gearbox
Pre-Upgraded Internals**



M249 MKII / PARA

Read Through Manual Before Use

Visit us at:

WWW.ECHO1USA.COM

-WARNING-

This AEG is FOR AGES 18 and above.

This AIRSOFT gun cause serious injury if misused. Full face protection is required.

Please read through the MANUAL BEFORE USE to avoid injuries or damages.

ECHO 1 User Manual

It is your **RESPONSIBILITY** to know your local and state laws regarding the **OWNERSHIP, USE and TRANSPORT** of your airsoft gun. If you are unsure of the laws, contact your local law enforcement agency or state government.



- Wear full eye and face protection at all times when handling or using an airsoft gun.
- Always keep your airsoft gun pointed in a safe direction.
- Always keep your airsoft gun unloaded until ready to use.
- Always keep your finger off the trigger until you are ready to shoot.
- Know your target and what is beyond it.
- Know how to operate your airsoft gun. (Refer to your owners manual)
- Use only the recommended BB's in your airsoft gun.
- Never use alcohol or over the counter, prescription or other drugs before or while shooting your airsoft gun.
- Store airsoft guns so they are not accessible to unauthorized persons.
- Make sure your airsoft gun is unloaded and battery has been removed prior to cleaning and storage.

Parts of the Gun

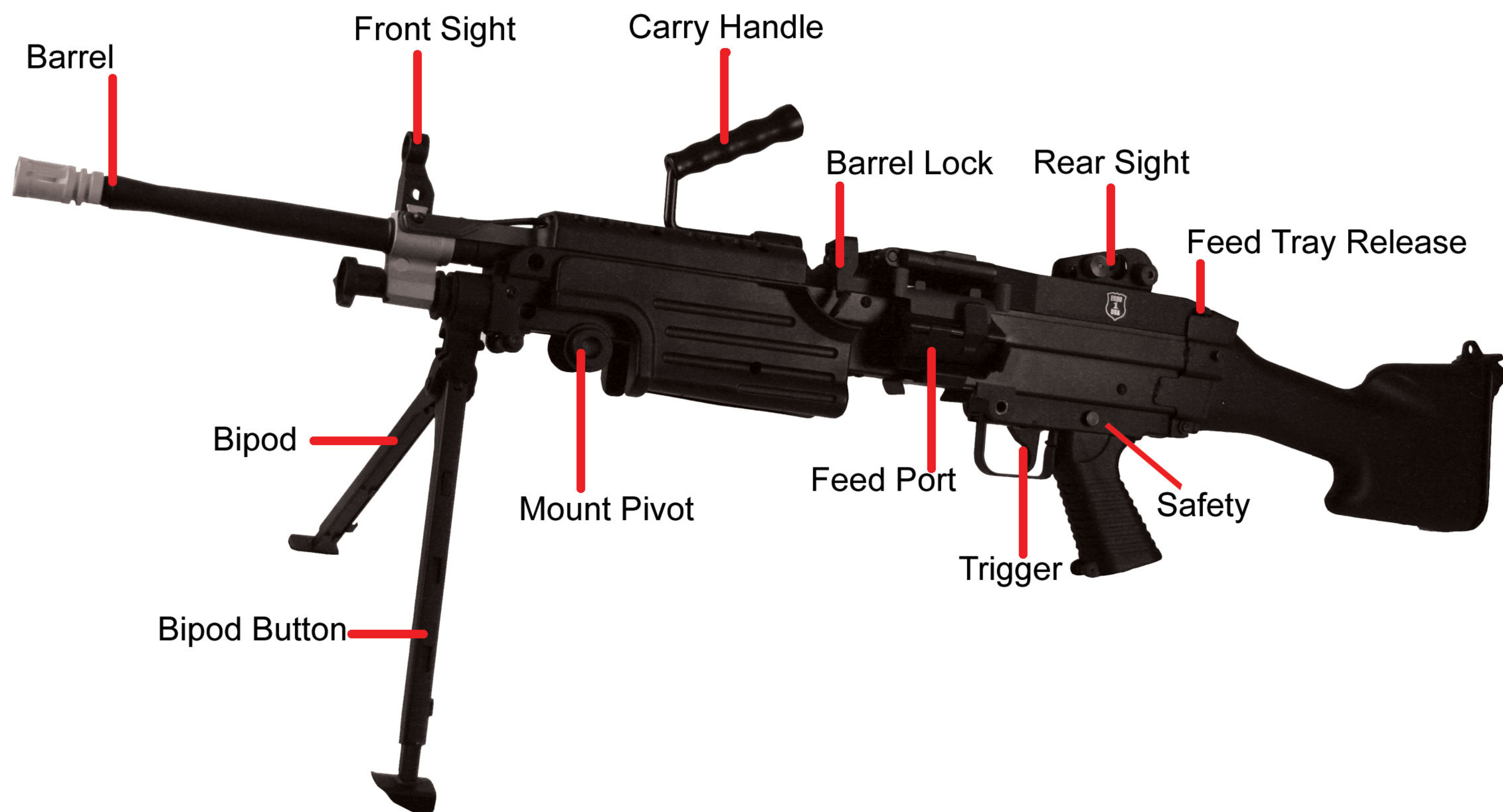
MKII



Specs of the Gun

Name of Gun	MKII	PARA
		
Weight	13lb	14lb
Barrel Length	509mm	363mm
Overall Length	1041mm	787mm
Barrel Caliber	6.08mm	6.08mm
BB Capacity	300/2500bb	300/2500bb
BB Size	6mm	6mm
Feet Per Second	350-360	350-360
Battery Type	8.4v Large or Mini	8.4v Mini

Selector Modes

The M249 series only have the Full Auto Fire Mode



FIRE: Safety Button is to the LEFT



SAFETY: Button is to the RIGHT

How to Install The Battery

MKII has battery storage in the stock.



STEP 1: Pull shoulder rest up.
STEP 2: Slide plate down.

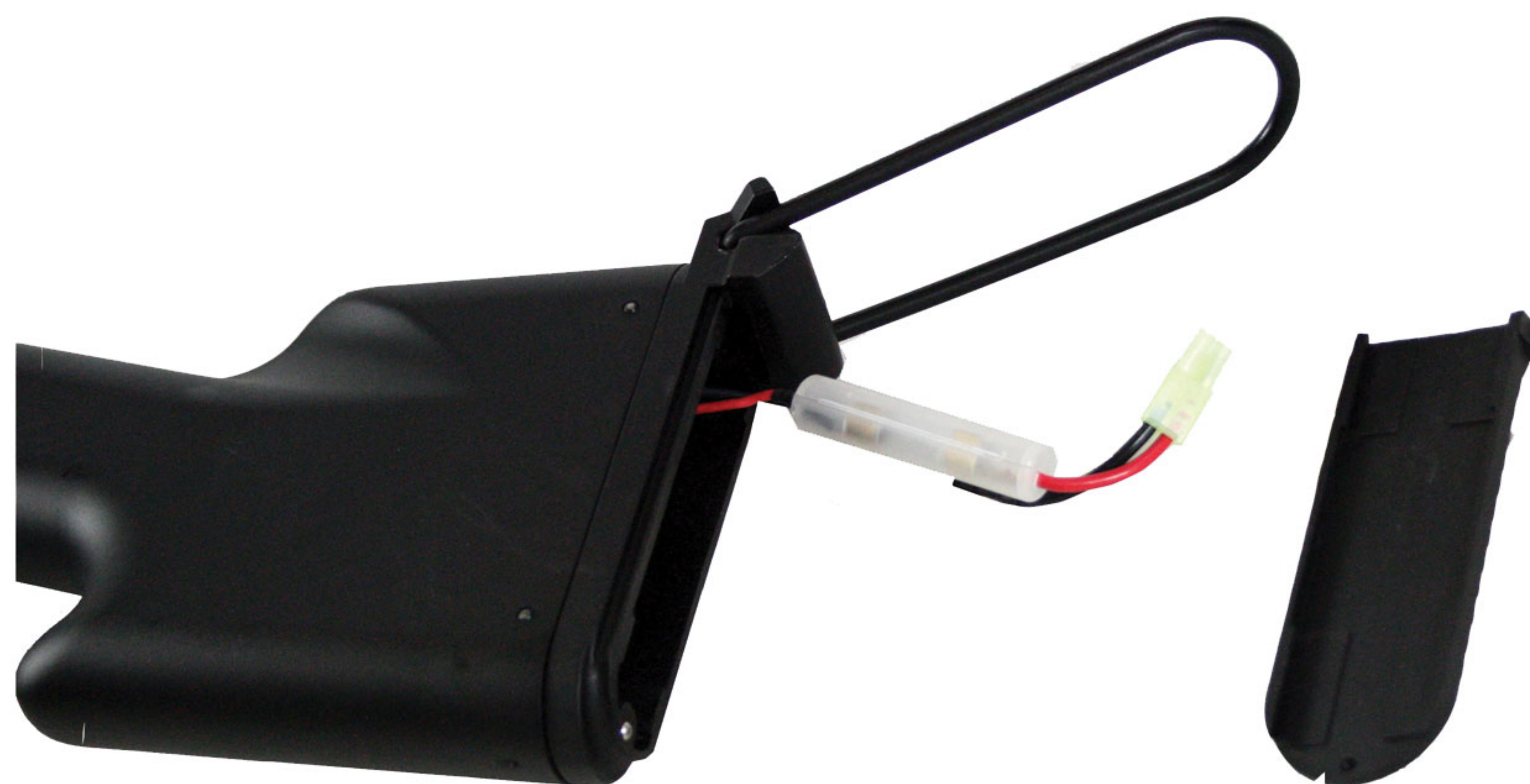

With the stock open insert battery and reverse steps 1 and 2.

PARA has battery storage in the front.



STEP 1: Pull the hand guard back and down to unhook.



STEP 2: Once hook is free pull away from gun.

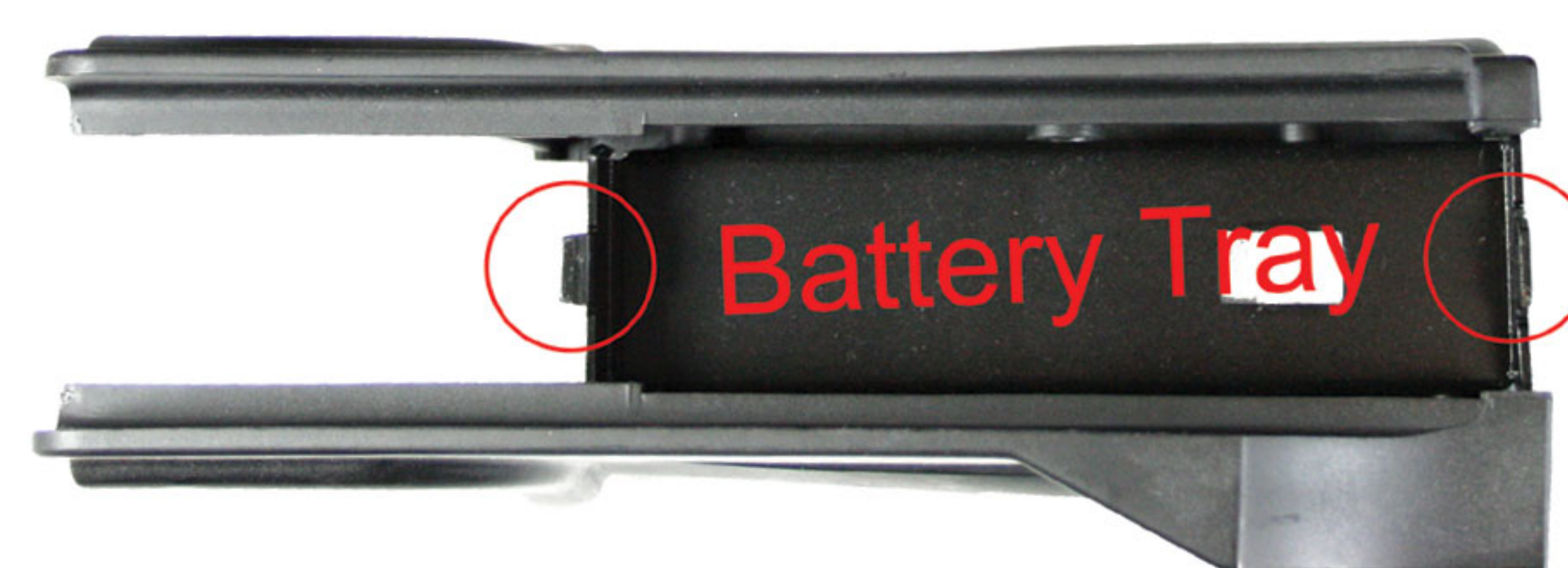

STEP 3: Insert battery into bottom of hand guard. The circled areas are the securing tabs.

How to Use the Magazine

The M249 box mag is an electric mag that uses 2 AA batteries. To get the box ready for use follow these steps.

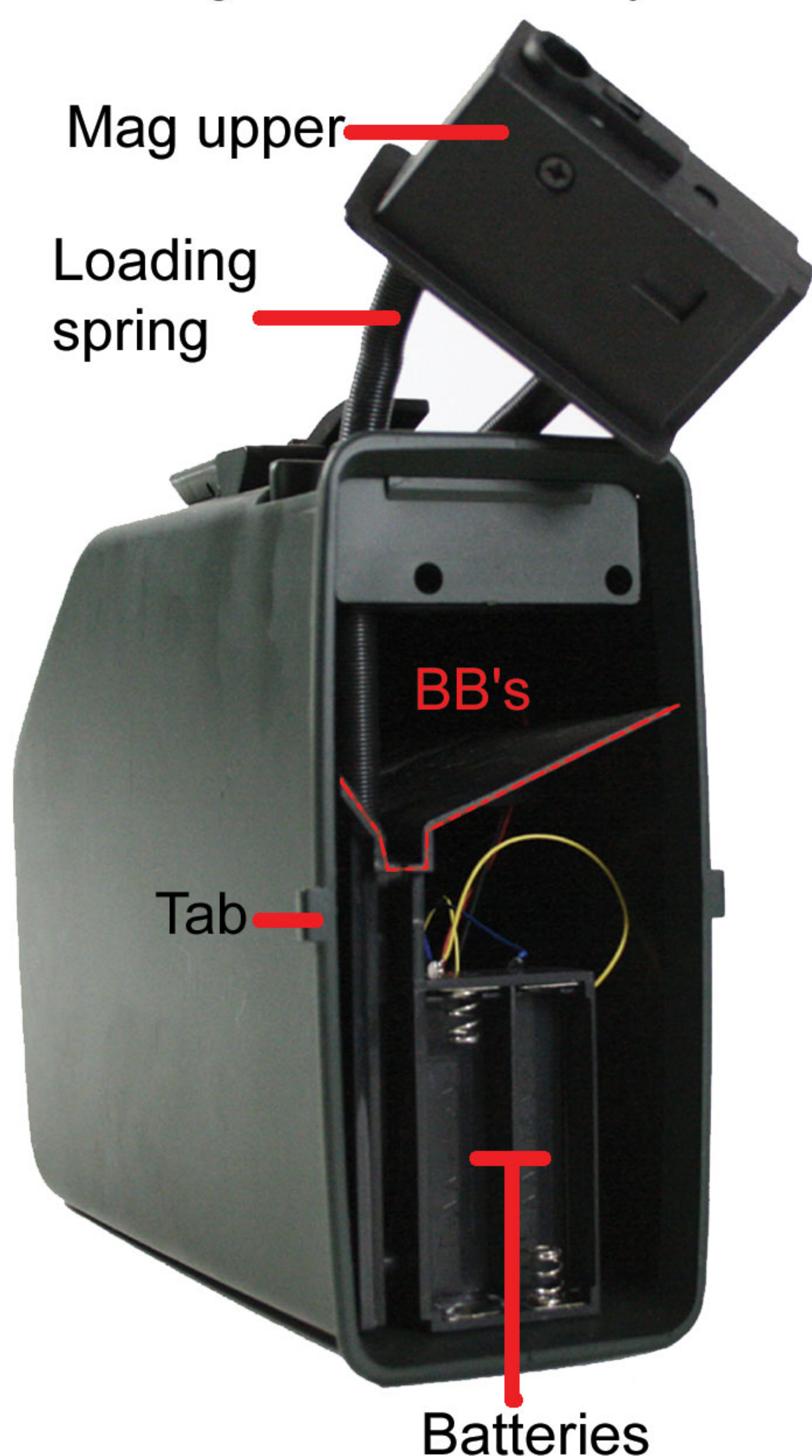

- STEP 1: Remove face plate of box. It is held in place by a tab on both sides and can be pulled off.
- STEP 2: Turn switch on the bottom to OFF. Correctly insert 2 AA batteries.
- STEP 3: Fill the upper half of the box with Echo 1 bb's. Keep bb's out of the lower portion of the box.
- STEP 4: Put face plate back on and secure both tabs.
- STEP 5: Insert the mag upper into the gun.
- STEP 6: Gently extend the loading spring while sliding the box under the gun and locking into place.
- STEP 7: Switch the box to AUTO to wind up the bb's. When bb's are present in loading springswitch to OFF.

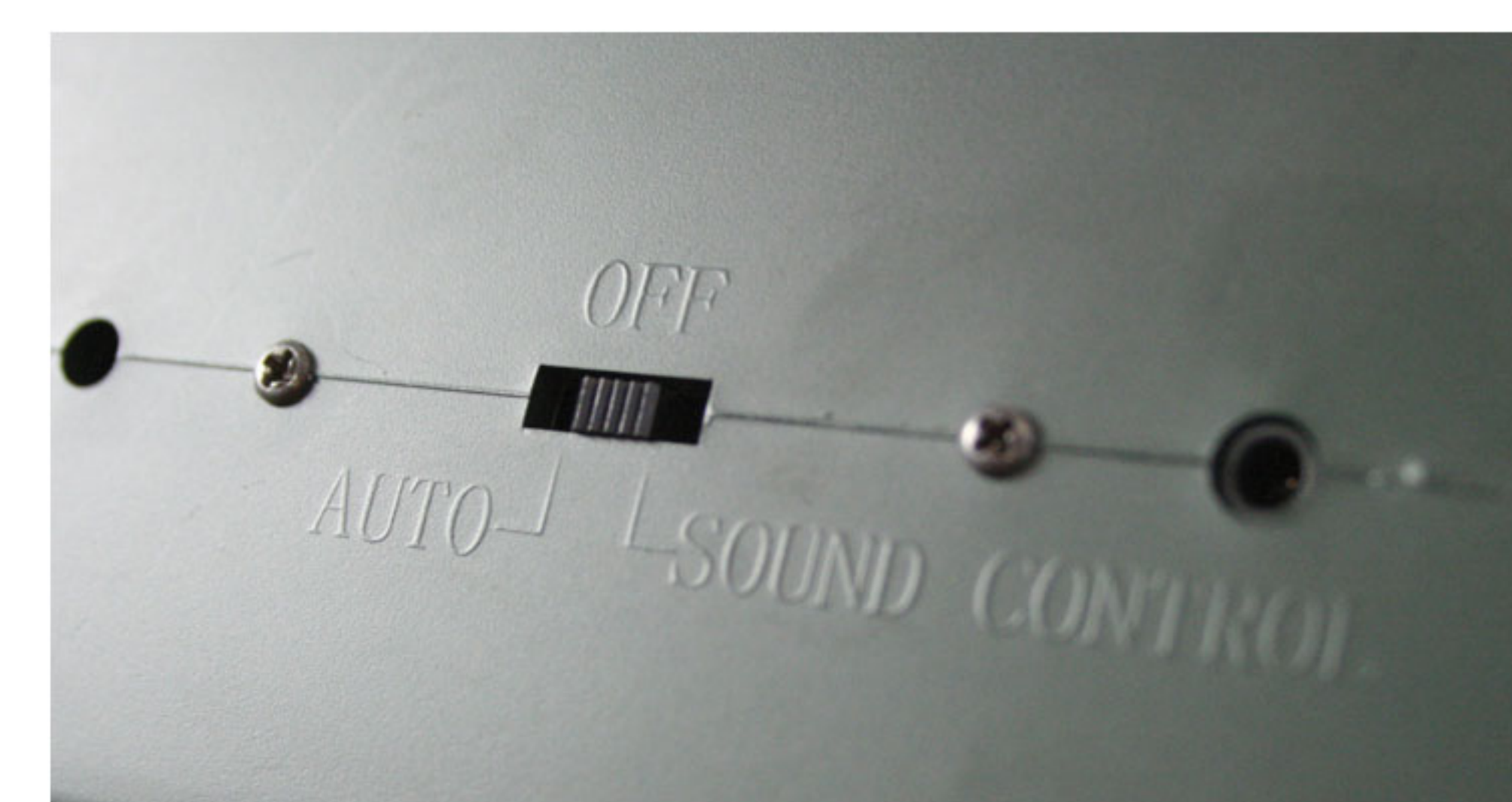

Switch Modes:

- AUTO: Winds up and loaded bb's. Do not leave on this setting when not shooting.
- OFF: No power to the box mag.
- SOUND CONTROL: Box will wind up after several shots.
- PLUG: Can be used with a pressure pad.

Operational Tips:

When loading and using the gun and mag keep dirt and debris out of the mag and loading system. To ensure best feeding keep the loading spring curved and not bent.

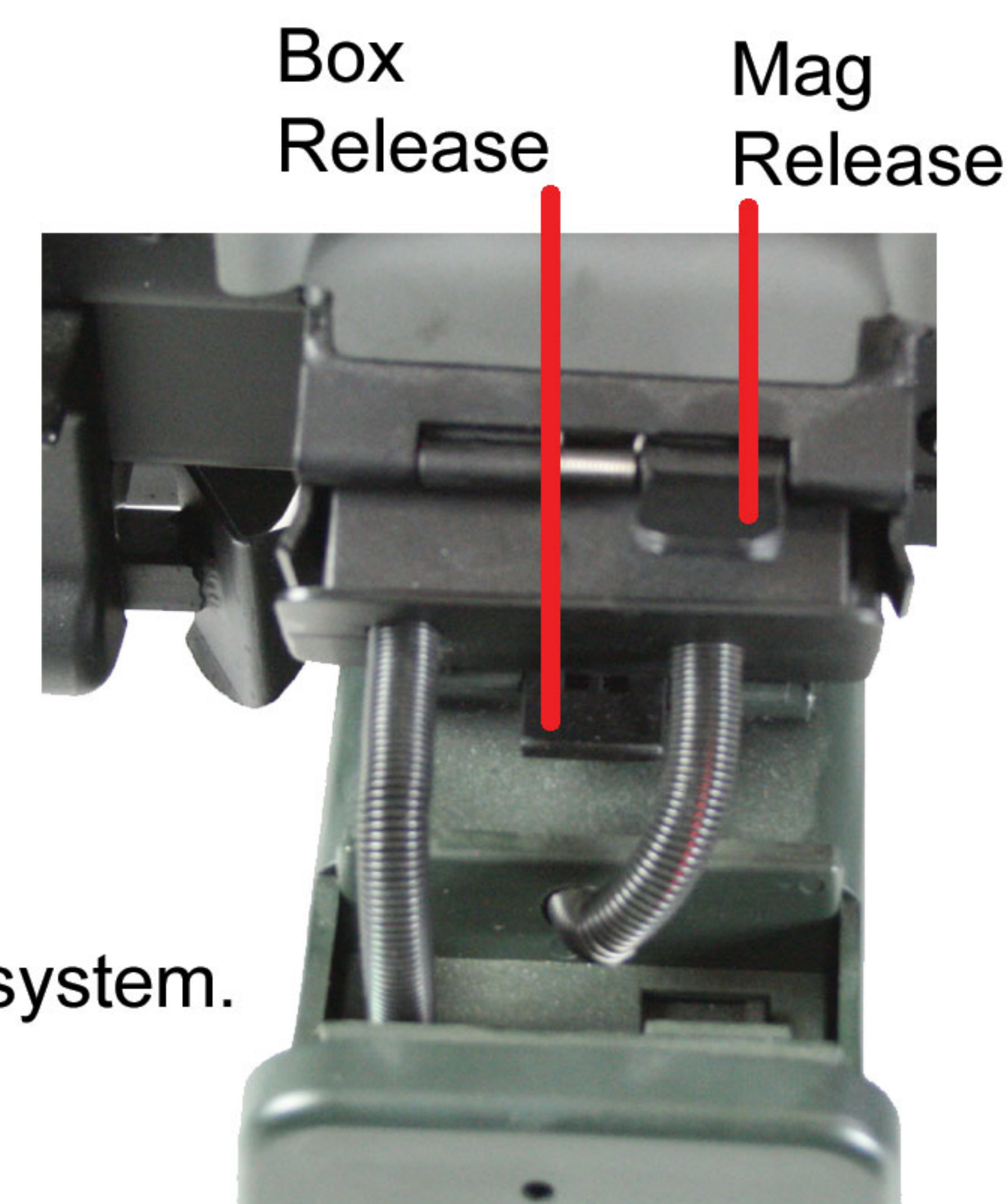

The Hop Up System

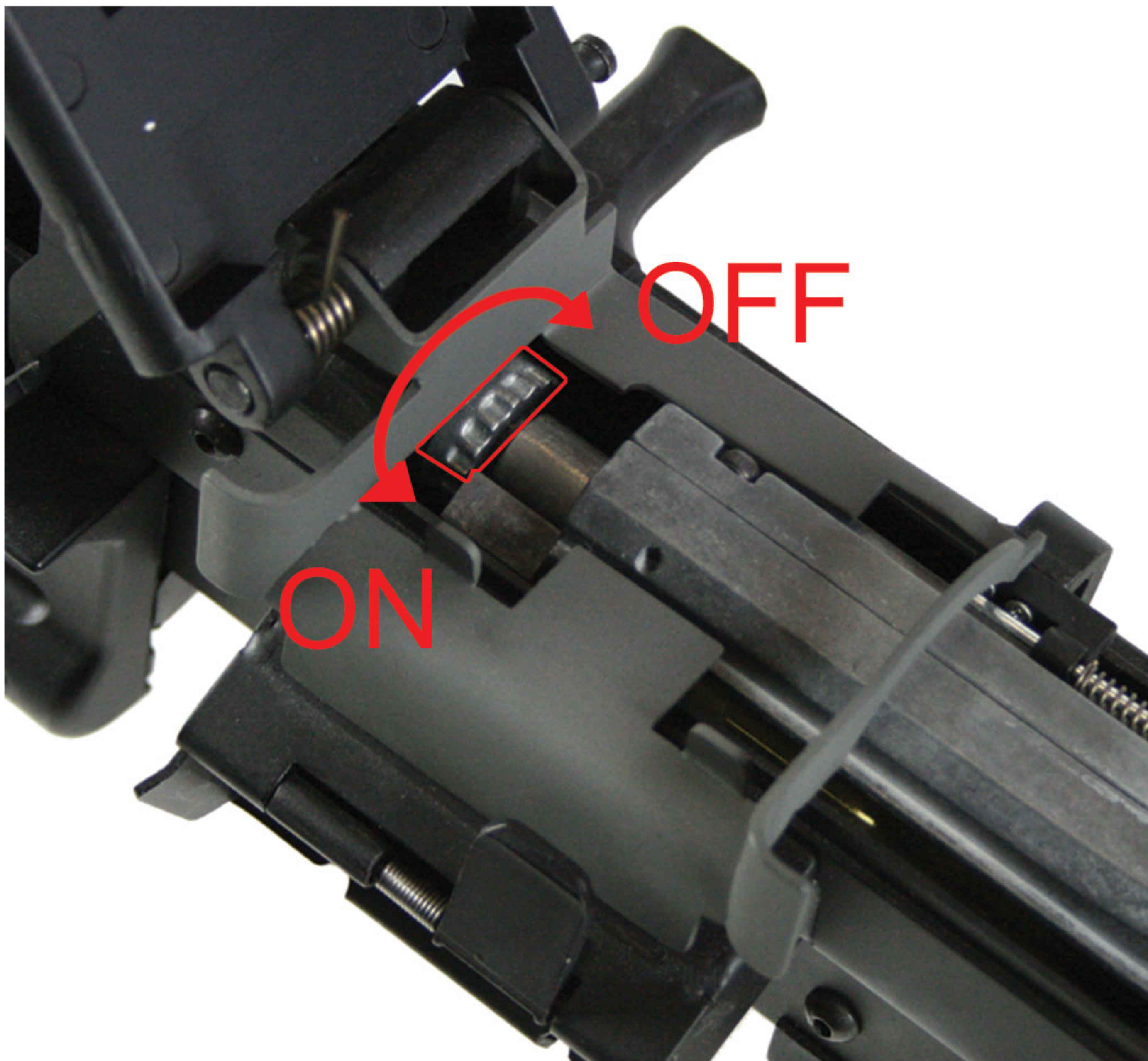

When adjusting the Hop Up do so in a safe area. To adjust the Hop Up release the feed tray. Turn the gray wheel to the left or right depending on how the bb's are going. The best setting is to have the bb's fly out straight or raise a foot and then drop for max range. If the hop is on too much the gun may jam.

Cleaning and Unjamming

If the gun jams stop shooting the gun. Turn the gun to SAFE and unplug the battery. Use the jamming rod and slide down the barrel as shown in the picture below. Only use airsoft oil or silicon oil on the hop up and other parts of the gun.

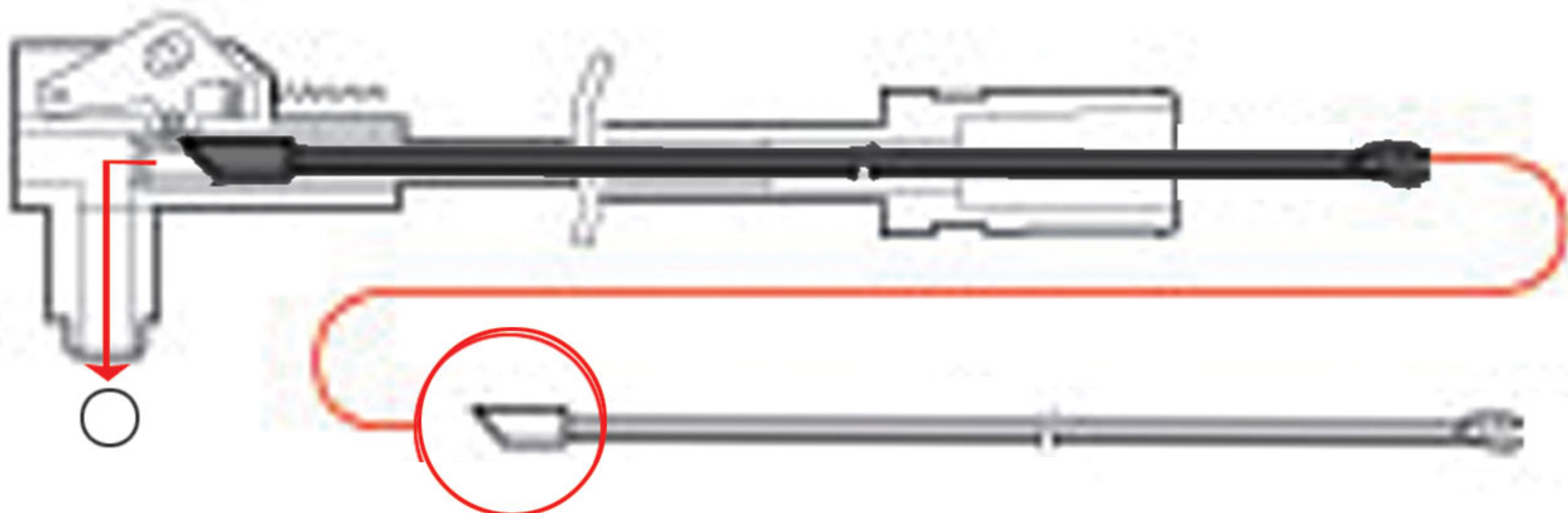

Takedown

The takedown process allows you to remove the barrel set for cleaning or unjamming. To remove the barrel set pull the barrel lock bar back. This is also used to secure the barrel when installing the barrel it will click when secure.



IMPORTANT:

Use only ECHO 1 BB's or BB's of equal quality consult your authorized ECHO 1 dealer for recommendations.



ECHO 1 6mm BB



Unpolished or used will jam



BB with mold line will jam



BB other than 6mm will jam

- When the barrel is removed DO NOT lose any parts.
- Pay attention on how the parts fit together.
- If the parts are forced together damage of the gun will occur.
- The Hop Up unit has a bar that slides into the loading ramp of the gun. There is only one way the hop up unit fits into the gun.

ECHO 1 User Manual

Trouble Shooting

What is the gun doing?	How to fix
Gun is making a clicking noise but not shooting.	Use a fully charged battery to unlock the gears.
The trigger is stuck and won't pull back in SEMI.	Switch the selector to FULL, fire 2-3 rounds and switch back to SEMI.
No power or noise coming from the gun.	Fuse may be blown. Replace with a 20A or 25A fuse found at most auto stores.
Grindy/Scratchy noise when shooting.	Motor height is too high/low. Turn allen screw at bottom of motor grip left or right until sound goes away.
Jamming or not shooting BB's.	Barrel is jammed, please check page 3.
Not working after troubleshoot.	Contact info@echo1usa.com on our site for more help.

